

FT-Z8Y SERIES

New

Chemical-resistant Rectangular Head Fiber



Chemical-resistant rectangular-shaped head with no light-beam misalignment.

Usable with various chemical liquids

With the case made of PFA (fluorine resin) and fiber sheath with PFA (fluorine resin), the fiber can be used with various types of chemical liquids.

Excellent explosion-proof structure complying with SEMI S2

Since the fiber does not have any electrical circuit in the sensing part, it offers an excellent explosion-proof structure.

Thru-beam side-view type with 3,500 mm 137.795 in long sensing range

The compact side-view type unit realizes a long sensing range of 3,500 mm 137.795 in (at **FX-301** LONG mode).

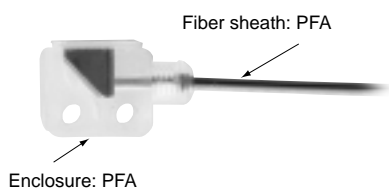

Easy cutting of even fluorine resin protected fiber

As the diameter of the fiber, including the fluorine resin protected portion, is only $\phi 2.2$ mm $\phi 0.087$ in, you can simply cut the fiber to a desired length.

Rectangular-shaped head provides easy mounting

The rectangular-shaped head offers both easy installation and easy light-beam alignment.

The head measures $7 \times 15 \times 13$ mm $0.276 \times 0.591 \times 0.512$ in, and can be mounted with M3 screws at two locations.

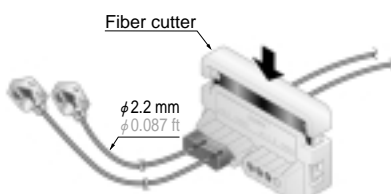

APPLICATIONS

Wafer cassette detection in a cleaning tank

Thanks to the PFA case and fiber sheath, the sensor can resist a wide assortment of liquid chemicals.

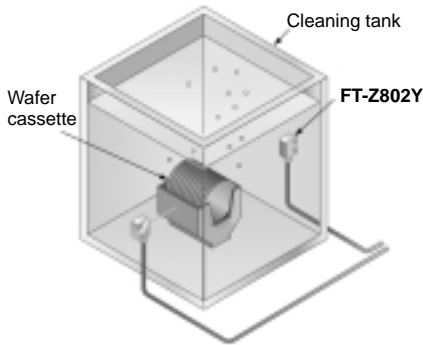

Chemical filling device

Because it is thru-beam type, there are no malfunctions due to the glass bottle's color. Of course, it can be used in a chemically preponderant atmosphere.

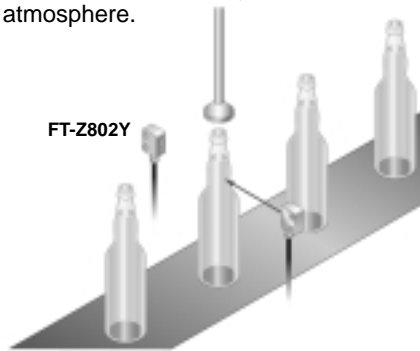

ORDER GUIDE

Fiber

Type	Shape of fiber head (mm in)	Sensing range (mm in)(Note)					Sensing object	Fiber cable length Free cut	Allowable bending radius	Model No.
		Red LED	Blue LED	Green LED	Infrared LED	FX-303 (H-SP mode)				
Chemical-resistant	W7 × H15 × D13 W0.276 × H0.591 × D0.512	3,500 137.795	320 12.598	160 6.299	320 12.598	830 32.677	φ4 mm φ0.157 in or more opaque object	2 m 6.562 ft	R25 mm R0.984 in	FT-Z802Y
		1,500 59.055	160 6.299	80 3.150	160 6.299					
		1,000 39.370	120 4.724	60 2.362	120 4.724					
		530 20.866	—	—	—					

Note: Please take care that the sensing range of the free-cut type fiber may be reduced by 20 % max. depending upon how the fiber is cut. In addition, the infrared type is easily affected by humidity, so contact our office if using these sensors in environments with high humidity or where humidity levels can fluctuate.

5 m / 7 m 16.404 ft / 22.966 ft fiber cable length type

5 m 16.404 ft and 7 m 22.966 ft fiber cable length types are also available. (Standard length: 2 m 6.562 ft)

Type	Model No.
5 m 16.404 ft fiber cable length type	FT-Z805Y
7 m 22.966 ft fiber cable length type	FT-Z807Y

Accessories

• FX-CT2

(Fiber cutter)

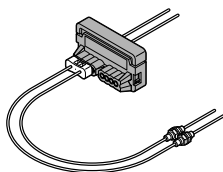

• FX-AT3

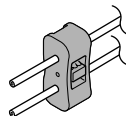

(φ2.2 mm φ0.087 in fiber attachment)
for FX-301/302/303/311 series



FT-Z8Y

ORDER GUIDE

Amplifiers Quick-connection cable is not supplied with the amplifier. Please order it separately.

Type	Appearance	Model No.	Emitting element	Output
Digital		FX-301	Red LED	NPN open-collector transistor
		FX-301P		PNP open-collector transistor
		FX-301B	Blue LED	NPN open-collector transistor
		FX-301BP		PNP open-collector transistor
		FX-301G	Green LED	NPN open-collector transistor
		FX-301GP		PNP open-collector transistor
		FX-301H	Infrared LED	NPN open-collector transistor
		FX-301HP		PNP open-collector transistor
High-functional digital		FX-302	Red LED	NPN open-collector transistor
		FX-302P		PNP open-collector transistor
Manually set		FX-311	Red LED	NPN open-collector transistor
		FX-311P		PNP open-collector transistor
		FX-311B	Blue LED	NPN open-collector transistor
		FX-311BP		PNP open-collector transistor
		FX-311G	Green LED	NPN open-collector transistor
		FX-311GB		PNP open-collector transistor

Quick-connection cables Quick-connection cable is not supplied with the amplifier. Please order it separately.

Type	Model No.	Description	
Main cable	CN-73-C1	Length: 1 m 3.281 ft	0.15 mm ² 3-core cabtyre cable, with connector on one end Cable outer diameter: ϕ 3.0 mm ϕ 0.118 in
	CN-73-C2	Length: 2 m 6.562 ft	
	CN-73-C5	Length: 5 m 16.404 ft	
Sub cable	CN-71-C1	Length: 1 m 3.281 ft	0.15 mm ² 1-core cabtyre cable, with connector on one end Cable outer diameter: ϕ 3.0 mm ϕ 0.118 in
	CN-71-C2	Length: 2 m 6.562 ft	
	CN-71-C5	Length: 5 m 16.404 ft	

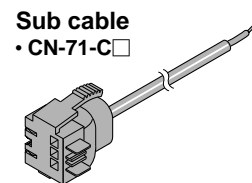
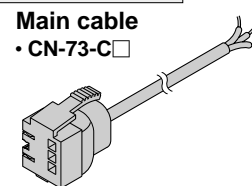

End plates End plates are not supplied with the amplifier. Please order it separately when the amplifiers are mounted in cascade.

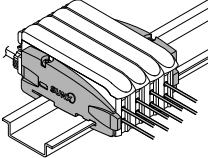
Appearance	Model No.	Description
	MS-DIN-E	When cascading multiple amplifiers, or when it moves depending on the way it is installed on a DIN rail, these end plates ensure that all amplifiers are mounted together in secure and fully connected manner. Two pcs. per set

SPECIFICATIONS

Refer to [p.77/p.119/p.138/p.166](#) for amplifiers specifications.

Type		Chemical-resistant
Item	Model No.	FT-Z802Y
Applicable amplifier		FX-301 series, FX-302(P), FX-303(P), FX-311 series
Sensing object		φ4 mm φ0.157 in or more opaque object
Allowable bending radius		R25 mm R0.984 in or more
Fiber cable length		2 m 6.562 ft free-cut
Protection		IP67 (except for the cut ends of the fiber)
Ambient temperature		0 to +60 °C +32 to +140 °F (No dew condensation), Storage: 0 to +60 °C +32 to +140 °F
Ambient humidity		35 to 85 % RH, Storage: 35 to 85 % RH
Material	Fiber cable	Fiber core: Acrylic, Sheath: PFA (Fluorine resin)
	Fiber head	Enclosure: PFA (Fluorine resin)
Accessories		FX-CT2 (Fiber cutter): 1 pc., FX-AT3 (φ2.2 mm φ0.087 in fiber attachment for FX-301/302/303/311 series): 1 pc.

PRECAUTIONS FOR PROPER USE

Refer to [p.1135~](#) for general precautions and [p.90/p.121/p.141/p.168~](#) for amplifiers precautions.



This product is not a safety sensor. Its use is not intended or designed to protect life and prevent body injury or property damage from dangerous parts of machinery. It is a normal object detection sensor.

Mounting

- Mount using M3 screws. The tightening torque should be 0.3 N·m or less.

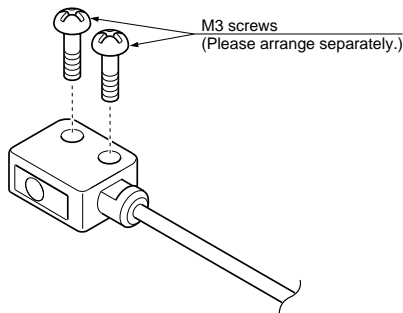

Cautions

- Keep the fiber head surface intact. If it is scratched or spoiled, the detectability will deteriorate.
- If the fiber head surface is dirty, wipe off the dirt with a clean soft cloth moistened with water.
- Do not use the fiber head surface in places where it may come in direct contact with water. A water drop on the fiber head surface deteriorates the sensing. No dew or liquid drop is present on surface of fiber head surface or sensing object.
- Do not apply excessive tensile force of the fiber cable.
- Bending radius of the fiber cable must be R25 mm R0.984 in or more. If the bending radius is smaller than the specified value, the sensing performance may deteriorate.
- Ensure that any strong extraneous light is not incident on the receiving face of the fiber head.
- The fiber cables should be cut off at the ends with the fiber cutter FX-CT2 (accessory) before insertion into the amplifier. Carefully cut and connect the fiber, as the sensing performance may deteriorate depending on the conditions of the cut part and/or of the connection to the amplifier.

Fiber attachment (FX-AT3)

- When the beam-emitting and beam-receiving fiber cables are inserted into the fiber sensor amplifier (FX-301/302/303/311 series etc.), the enclosed fiber attachment (FX-AT3) facilitates insertion of the fiber cables and reduces the possibility of incorrect fiber cable insertion.

<Cautions>

Take care that FX-AT3 cannot be used with fiber sensor amplifiers having a pitch, between the beam-emitting and the beam-receiving fiber cables, other than 7 mm 0.276 in.

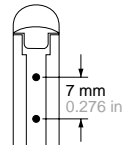

Mounting

- Confirm that the fiber lock button of FX-AT3 is in unlock side.
- Insert the fiber cables one by one, in condition ①.
- After inserting, press down the fiber lock button. The fiber cables are fixed at the desired position. (In order to unlock the fiber cables, press the fiber lock button towards unlock direction from the opposite side.)
- Insert the fiber cables into the holes for φ2.2 mm φ0.087 in fiber cables of the fiber cutter (FX-CT2) from the direction shown in the figure below.

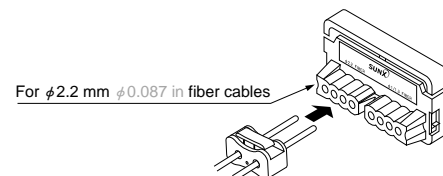
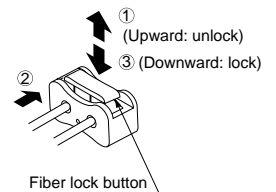

- Cut both fiber cables simultaneously. (At this time, place the attachment without any gap against the fiber cutter. The fiber cables will be cut at a position approx. 10.5 mm 0.413 in from the tip of the fiber cable.)
- After cutting, connect the fiber cables to the fiber sensor amplifier immediately.

FT-Z8Y

PRECAUTIONS FOR PROPER USE Refer to p.1135~ for general precautions and p.90/p.121/p.141/p.168~ for amplifiers precautions.

Fiber cutter (FX-CT2)

• To cut the fiber cables, insert them from the direction shown below.

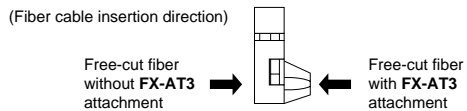

③ Slide part (A) of the fiber cutter down to cut the fiber cables.

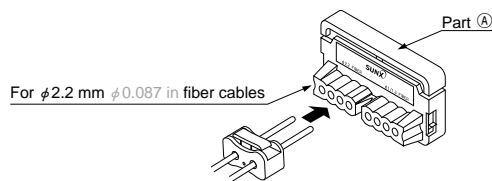

How to use fiber cutter (FX-CT2)

- ① Slide part (A) of the fiber cutter fully upward till it stops.
- ② Insert the fiber cables, mounted in the attachment, till they stop.
 (Take care that there are separate fiber cable insertion holes for $\phi 2.2$ mm $\phi 0.087$ in and $\phi 1$ mm $\phi 0.039$ in or $\phi 1.3$ mm $\phi 0.051$ in fiber cables.)

- Notes:
- 1) The fiber cables should be cut in one stroke.
 - 2) Once a fiber cable is cut off at a hole, do not use the hole again. If used, it degrades the cut surface quality and the detectability may deteriorate.
 - 3) The blade cannot be replaced. Please purchase an additional fiber cutter, if required.
 - 4) Note that the sensing range may be reduced by up to 20 % depending on the cut condition. Hence, decide the setting distance by taking sufficient margin.

DIMENSIONS (Unit: mm in) The CAD data in the dimensions can be downloaded from the SUNX website: <http://www.sunx.co.jp/> Refer to p.102/p.127/p.143/p.170 for amplifiers dimensions.

