

UA-11

Tank Level Sensor

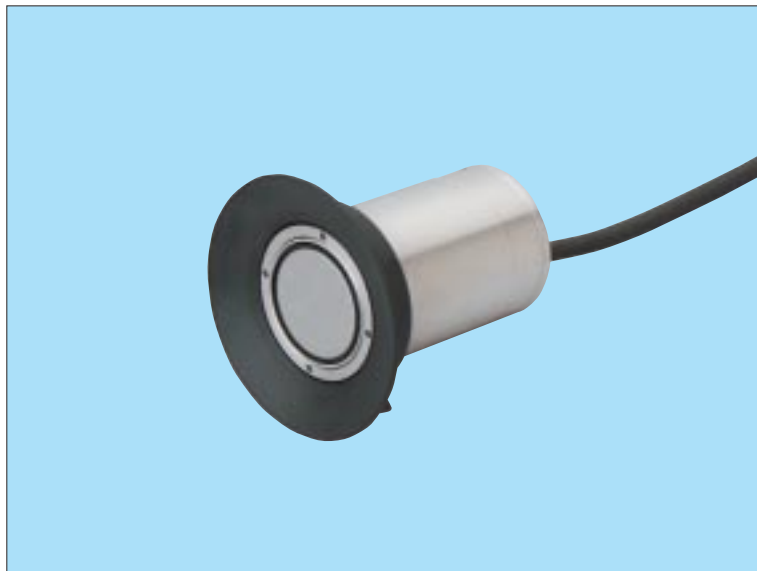

Non-contact Liquid Level Detection in Reservoirs



Non-contact Liquid Level Detection

UA-11 detects the inner liquid level from outside the tank, keeping the contents intact. Useful for tank storing corrosive liquids or tanks storing pure liquids in the food, medical, and pharmaceutical industries where hygiene is important.

Easy Installation on Tank Wall

No opening is required in the wall to install UA-11. It is mountable by a metal belt fastened around the tank or by a bracket welded on the tank.

Easy Internal Cleaning of Tank

There is no need to remove UA-11 for washing the inside of the tank because of its outside placement.

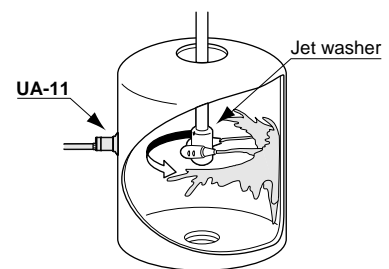
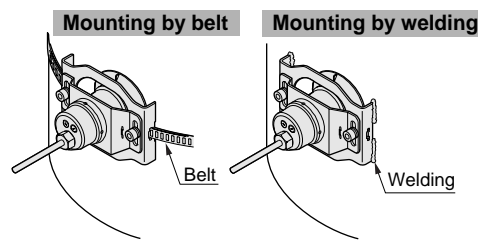
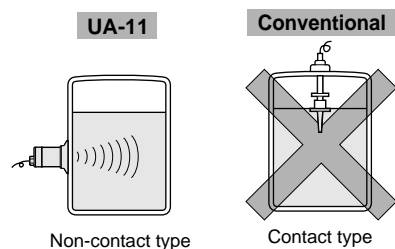

No Controller Required

As the amplifier is built-in, no additional controller is needed. Further, the 5m long attached cable can be extended up to 100m overall.

Two Bright Indicators Incorporated

It incorporates a red operation indicator and a green stability indicator to reveal the operating conditions at a glance.

Sound Emission Lock

This function is useful for a sensor operation check or a mutual interference prevention check by stopping the ultrasonic emission.

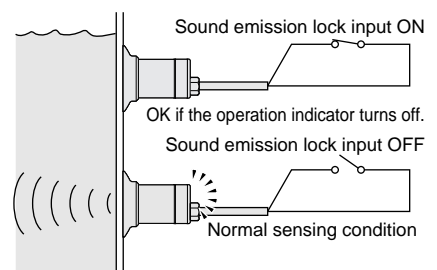
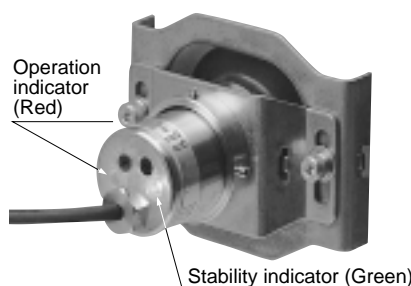
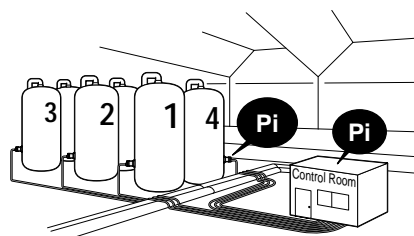

APPLICATIONS

High/Low level control

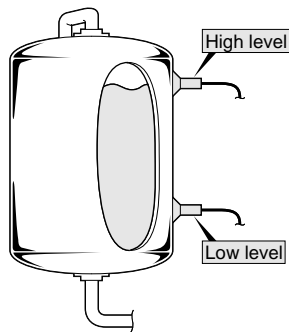

Multiple level detection

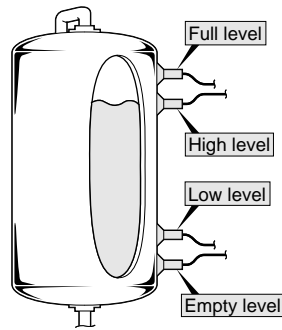

CAUTIONS

UA-11 cannot be used with the following tank constructions.

- A multi-layered tank, such as, a tank having a thermal insulating jacket for cooling or heat-retaining
- A cone-shaped tank
- A tank with a pipe, a fin, a stirrer, an agitator, or a shaker inside, which obstructs the sound propagation
- A tank having a resin lining
- A tank storing liquid that is highly viscous, or includes grains, bubbles, or layers of different ingredients

ORDER GUIDE

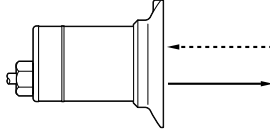
Type	Appearance	Model No.	Applicable tank (Note 1)			Contents
			Tank diameter (Note 2)	Wall thickness (Note 2)	Material (Note 3)	
Amplifier built-in ultrasonic		UA-11	$\phi 300$ to $\phi 3,000$ mm	6mm or less	Metal (Stainless steel, Iron etc.)	Water or liquid having similar viscosity (without bubbles)

- Notes: 1) It cannot be used for multi-layered tanks, such as, a tank having thermal insulating jacket for refrigeration, heat-retaining, etc.
 2) The allowable tank diameter and the wall thickness may vary from the above due to the contents and/or the tank shape. Please enquire for details.
 3) It cannot be used for tanks made of resin.

OPTIONS

Designation	Model No.	Description
Tank-side mounting bracket	MS-UA11-1	It holds MS-UA11-2 mounted on UA-11 .
Steel belt	UA-B10	Length: 10m
	UA-B20	Length: 20m
Buckle	UA-BK1	It fastens the belt UA-B

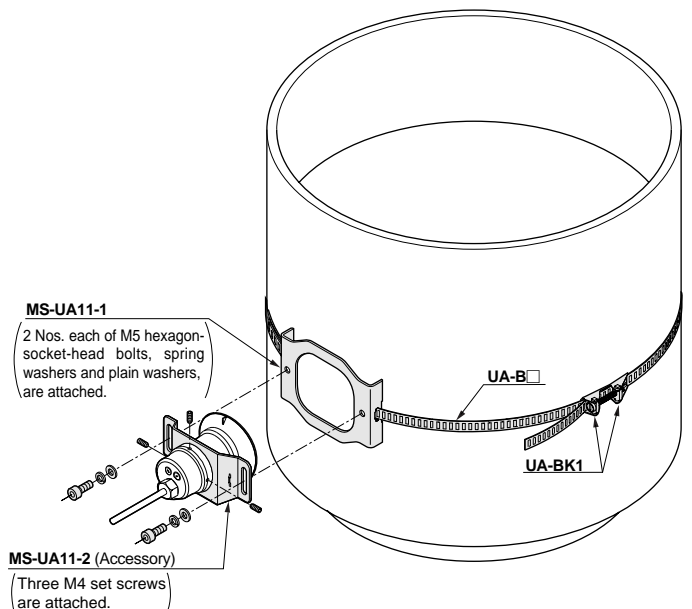

Water Detection Wire Flaw Detection Hot Melt Glue Detection
 EZ-10 LA-T TH
 Liquid Level Sensing
 FD-F8Y FD-F4/F9
 UA-11

UA-11

SPECIFICATIONS

Type		Amplifier built-in-ultrasonic
Item	Model No.	UA-11
Applicable tank (Note 1)	Tank diameter (Note 2)	ϕ 300 to ϕ 3,000mm
	Wall thickness (Note 2)	6mm or less
	Material (Note 3)	Metal (stainless steel, iron etc.)
Contents		Water or similar viscosity liquid (without bubbles)
Supply voltage		12 to 24V DC \pm 10% Ripple P-P 10% or less
Current consumption		60mA or less
Repeatability		\pm 3mm (with water)
Output (Output 1, Output 2)		NPN open-collector transistor <ul style="list-style-type: none"> • Maximum sink current: 100mA • Applied voltage: 30V DC or less (between output and 0V) • Residual voltage: 1.5V or less (at 100mA sink current) 1V or less (at 40mA sink current)
Utilization category		DC-12 or DC-13
Output operation		Output 1: ON when liquid is detected, Output 2: OFF when liquid is detected
Short-circuit protection		Incorporated
Response time (Note 4)		5ms approx. (for 3,000mm tank diameter with water inside)
Operation indicator		Red LED (lights up when Output 1 is ON)
Stability indicator		Green LED (lights up under stable operation)
Sound emission lock function		Incorporated
Interference prevention function		Incorporated
Pollution degree		3 (Industrial environment)
Protection		IP67 (IEC)
Ambient temperature		- 10 to + 80°C (No dew condensation or icing allowed), Storage: - 20 to + 90°C
Ambient humidity		35 to 85% RH, Storage: 35 to 85% RH
EMC		Emission: EN50081-2, Immunity: EN50082-2
Voltage withstandability		1,000V AC for one min. between all supply terminals connected together and enclosure
Insulation resistance		20M Ω , or more, with 250V DC megger between all supply terminals connected together and enclosure
Vibration resistance		10 to 500Hz frequency, 1.5mm amplitude in X, Y and Z directions for two hours each
Shock resistance		500m/s ² acceleration (50G approx.) in X, Y and Z directions for three times each
Enclosure earthing		Capacitor earth
Material		Enclosure: Stainless steel (SUS304), Indicating part: PFA, Skirt: EPR, Adjuster: PPS
Cable		0.2mm ² 6-core cabtyre cable, 5m long
Cable extension		Extension up to total 100m is possible with 0.5mm ² , or more, cable.
Weight		310g approx.
Accessories		MS-UA11-2 (Sensor-side mounting bracket): 1 No., UA-G1 (Paste): 1 No., Adjusting screwdriver: 1 No.

- Notes: 1) It cannot be used for multi-layered tanks, such as, a tank having thermal insulating jacket for refrigeration, heat-retaining, etc.
 2) The allowable tank diameter and the wall thickness may vary from the above due to the contents and/or the tank shape. Please enquire for details.
 3) It cannot be used for tanks made of resin.
 4) The response time varies with the tank diameter and the type of liquid. Please enquire for details.

I/O CIRCUIT AND WIRING DIAGRAMS

I/O circuit diagram

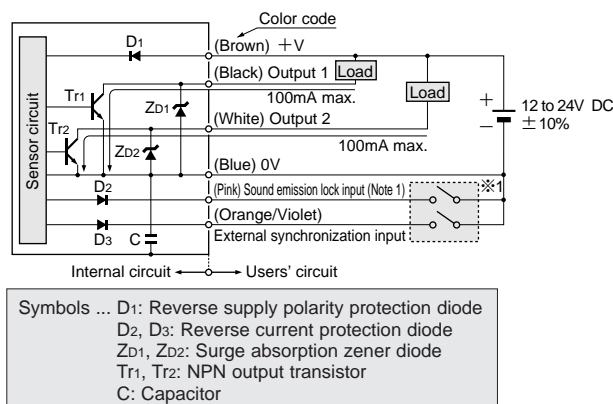

Wiring diagram

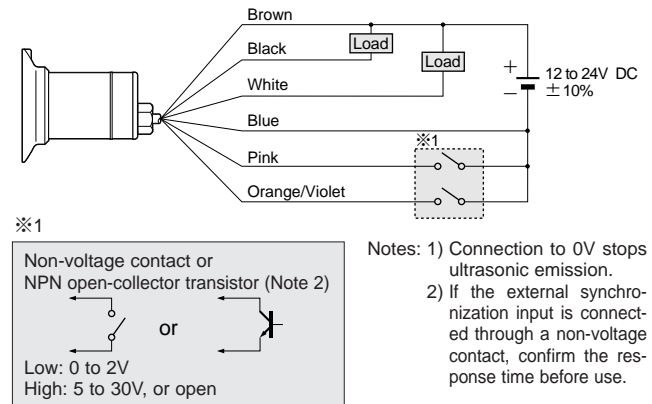

PRECAUTIONS FOR PROPER USE



This product is not a safety sensor. Its use is not intended or designed to protect life and prevent body injury or property damage from dangerous parts of machinery. It is a normal liquid detection sensor.

Mounting

- Align the upper part of the sensor-side mounting bracket (**MS-UA11-2**) with the position on the tank diameter scale, on the sensor main body, which corresponds to the used tank diameter, and fix with M4 (length 6mm) set screws at three points.
The tightening torque should be 0.58N·m or less.

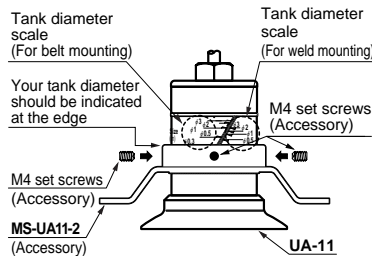

- Fix the optional tank-side mounting bracket **MS-UA11-1** on the tank by belt mounting or weld mounting as follows.

Belt mounting

- Prepare two belts of different lengths by cutting **UA-B** with nippers. One should be over 500mm long. The second belt should be approximately the tank circumference minus 200mm. Round the cut ends of the belts to avoid any injury.
- Insert one end of the 500mm belt through the trapping slot on one side of **MS-UA11-1** and fold it back inside 100mm or more. Insert the other end through the slit on the **UA-BK1** buckle and fold it back inside 100mm or more. The distance between **MS-UA11-1** and **UA-BK1** should be 300mm or more.

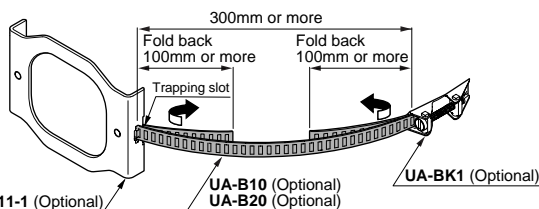

- Insert one end of the other belt through the trapping slot on the other side of **MS-UA11-1** and fold it back inside 100mm or more.

- Route it around the tank and insert its other end through the **UA-BK1** buckle over the first belt as shown. Pull it tight and engage it on the hook of the buckle.

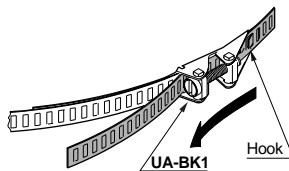

- Tighten the belts by screwing at the buckle with a 'minus' screwdriver. The tightening torque should be 0.74N·m approx. Take care not to deform the tank by tightening.

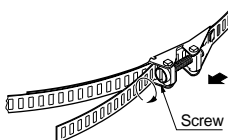

- Notes:
- Use two or more **UA-BK1** buckles around a large tank, 2m or more in diameter.
 - The belts (**UA-B**) should be fastened so as to be parallel to a horizontal section of the tank. If not, as the belt becomes loose, the detectability will deteriorate.
 - Do not mount with a belt on a cubic tank. In this case mount by welding.

Weld mounting

- Weld **MS-UA11-1** on the tank wall at the four corners.

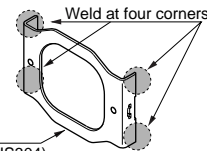

MS-UA11-1 (Optional)
Material: Stainless steel (SUS304)

- Note: Welding may yield a gap between the tank-side mounting bracket (**MS-UA11-1**) and the tank's outer wall. In this case, since the tank diameter scale cannot be used as is, when the sensor is fixed on the sensor-side mounting bracket (**MS-UA11-2**), set the sensor at a position which is shifted, with respect to the position indicated by the tank diameter scale, towards the cable side by an amount equal to the gap. The following procedure may also be used to set the sensor.
- The sensor is pressed tightly against the tank's outer wall.

- Under the condition of ③, fix the sensor and the sensor-side mounting bracket (**MS-UA11-2**) with M4 (length 6mm) set screws at such a position that there is a gap of 5mm approx. between the tank-side mounting bracket (**MS-UA11-1**) and the sensor-side mounting bracket (**MS-UA11-2**).

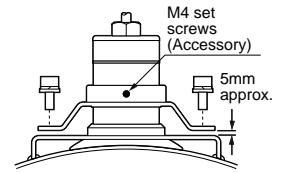

- Apply the **UA-G1** paste (accessory), approx. 15mm long, on the sensing face. Spread it smoothly over the sensing face and the skirt. Take care that air bubbles are not produced.

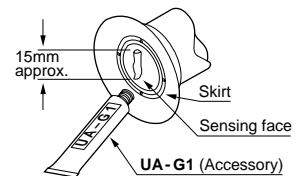

- Fix **MS-UA11-2** holding the sensor to **MS-UA11-1** with two M5 (length 15mm) hexagon-socket-head bolts. Each bolt must be fitted with a spring and a plain washer. Tighten the bolts alternately so that the sensing face contacts the tank surface evenly and the sensor is perpendicular to the wall surface. The tightening torque should be 2.94N·m or less. Do not deform the tank by tightening.

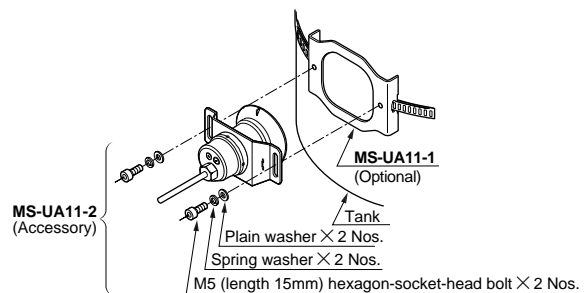

- Note: If the tightening is insufficient, unbalanced or incorrect, it weakens the pressure of the sensing face against the tank wall, generating a tilt. Uneven surface contact will lead to incorrect sensor operation.

Hot Melt Glue Detection TH

Wire Flaw Detection LA-T

Water Detection EZ-10

EX-F1

Liquid Level Sensing FD-F4/F9

FD-F8Y

UA-11

UA-11

PRECAUTIONS FOR PROPER USE

Caution on mounting



- Always handle the edges of the belts (UA-B□) carefully to avoid any injury.
- In case the paste enters your eye, wash your eyes thoroughly with water and consult an eye doctor immediately.
- If the paste sticks to your skin, wash it off thoroughly with water.

- Make sure to test for compatibility with your tank before actual use.

UA-11 cannot be used with the following tank constructions.

- A multi-layered tank, such as, a tank having a thermal insulating jacket for cooling or heat-retaining
- A cone-shaped tank
- A tank with a pipe, a fin, a stirrer, an agitator, or a shaker inside, which obstructs the sound propagation
- A tank having a resin lining
- A tank storing liquid that is highly viscous, or includes grains, bubbles, or layers of different ingredients

- Keep air out of the contact section between the sensing face and the tank wall.
- Remove paint, rust, moisture, dirt, and dust off the mounting surface of the tank with sand paper or a cloth dampened with ethyl alcohol before mounting the sensor.
- At the time of shifting the sensor position, remove the sensor from the tank, completely wipe the paste off the sensor head, and apply fresh paste.
- Do not keep the paste in places exposed to direct sunlight or having high humidity.
- The scale on the sensor body is calibrated only for a cylindrical tank when using **MS-UA11-1** and **MS-UA11-2**.
- Waves on the liquid surface may cause the output and the operation indicator to flicker. This does not indicate any abnormality.
- A flow in the liquid may affect the detectability.
- If the paste flows out from the contact section between the sensing face and the tank wall, the detectability may deteriorate. Keep the contact section away from chemical agents, or heavy splashes of water.
- If the tank wall is much thicker than the specified range or the sensitivity is too high for the tank size, the derivative sound returned around the tank wall may cause the sensor to generate an output with no liquid. In this case, reduce the sensitivity, and check that the output is ON when the liquid level is higher than the sensing point, and OFF when the level is lower than it, up to the empty state.
- Make sure to test for compatibility with your tank before actual use.



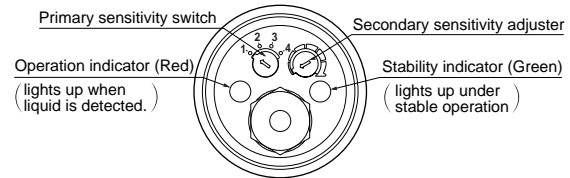

Calibration

Back face



Sensitivity adjustment

<Adjusting Procedure>

Step	Operation	Sensitivity switch/adjuster										
①	Set the primary sensitivity switch for your tank using the following table as a reference. <table border="1" data-bbox="933 779 1236 896"> <thead> <tr> <th>Primary sensitivity switch</th> <th>Tank diameter (mm)</th> </tr> </thead> <tbody> <tr> <td>1</td> <td>φ300 to φ500</td> </tr> <tr> <td>2</td> <td>φ500 to φ1,000</td> </tr> <tr> <td>3</td> <td>φ1,000 to φ2,000</td> </tr> <tr> <td>4</td> <td>φ2,000 to φ3,000</td> </tr> </tbody> </table> Note: The relationship between the switch setting and the tank diameter differs with the liquid viscosity, the mounting conditions, etc.	Primary sensitivity switch	Tank diameter (mm)	1	φ300 to φ500	2	φ500 to φ1,000	3	φ1,000 to φ2,000	4	φ2,000 to φ3,000	 Primary sensitivity switch
Primary sensitivity switch	Tank diameter (mm)											
1	φ300 to φ500											
2	φ500 to φ1,000											
3	φ1,000 to φ2,000											
4	φ2,000 to φ3,000											
②	Turn the secondary sensitivity adjuster fully counterclockwise to the minimum sensitivity.	 Secondary sensitivity adjuster										
③	Fill the tank until the level is higher than the sensor mounting position. Turn the adjuster gradually clockwise up to the point (A) where both the operation indicator and the stability indicator light up. If the indicators do not light up, even if the adjuster is turned fully clockwise, shift the primary sensitivity switch up one position on the scale and perform steps ② and ③ again.	 Secondary sensitivity adjuster										
④	Drain the contents from the tank until the level is lower than the sensor mounting position. Make sure that the operation indicator lights off and the stability indicator lights up. Turn the adjuster clockwise until the operation indicator lights up again. After it lights up, turn the adjuster slightly counterclockwise to the point (B) where the indicator lights off.	 Secondary sensitivity adjuster										
⑤	Set the adjuster at the center between the points (A) and (B), which is the optimum sensitivity position.	 Secondary sensitivity adjuster										

Enclosure earthing

- UA-11 utilizes capacitor earthing to improve noise characteristics.

Do not use any auto-transformer (single winding transformer) to supply power.

PRECAUTIONS FOR PROPER USE

Sound emission lock function

- The emission of sound is suspended when the sound emission lock input is connected to 0V. This can be used to check the sensor operation while the level is higher than the sensor mounting position, and to check interference prevention.

Interference prevention function

- If two or more sensors are adjacently mounted on a tank, mutual interference may occur. Interference can be prevented using the interference prevention function by the input of external synchronization signals so that each sensor operates as per the synchronization signal timing.

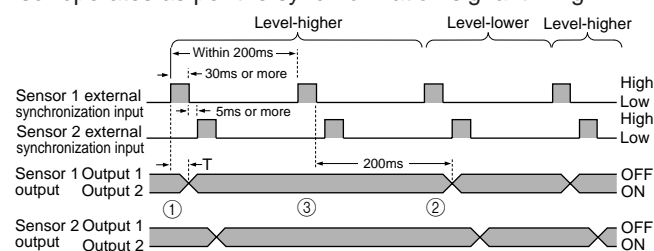

T: Depends on the tank diameter and the type of liquid
(e.g., T = 5ms approx. for 3,000mm tank diameter and with water as the liquid.)

- When there is a change from liquid absent to liquid present condition, the output changes T sec. after the rise of the external synchronization input.
- 200ms after the fall of the external synchronization input, if water continues to be present, the output is maintained and if water is absent, the output changes at this instant.

Wiring

- Make sure to carry out the wiring in the power supply off condition.
- Verify that the supply voltage variation is within the rating.
- If power is supplied from a commercial switching regulator, ensure that the frame ground (F.G.) terminal of the power supply is connected to an actual ground.
- In case noise generating equipment (switching regulator, inverter motor, etc.) is used in the vicinity of this product, connect the frame ground (F.G.) terminal of the equipment to an actual ground.
- Make sure to connect the metal tank on which **UA-11** is mounted to the frame ground (F.G.) terminal.
- Do not run the wires together with high-voltage lines or power lines or put them in the same raceway. This can cause malfunction due to induction.

Others

- Do not use during the initial transient time (50ms) after the power supply is switched on.

Hot Melt Glue Detection

TH

Wire Flaw Detection

LA-T

Water Detection

EZ-10

Liquid Level Sensing

EX-F1

FD-F4□/F9□

FD-F8Y

UA-11

UA-11

DIMENSIONS (Unit: mm)

UA-11 Sensor

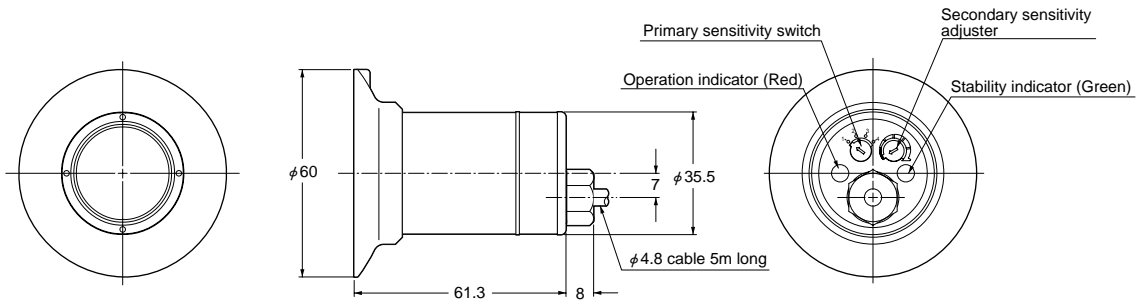

MS-UA11-2 Sensor-side mounting bracket (Accessory)

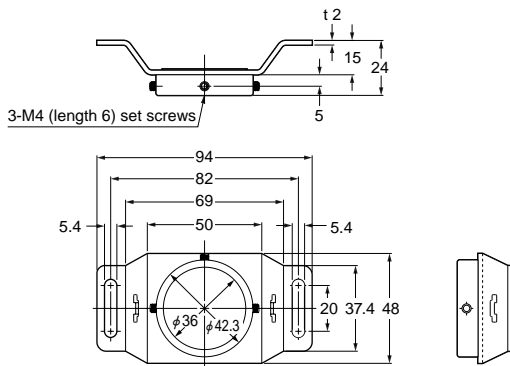

Material: Stainless steel (SUS304)
Three M4 (length 6mm) set screws are attached.

MS-UA11-1 Tank-side mounting bracket (Optional)

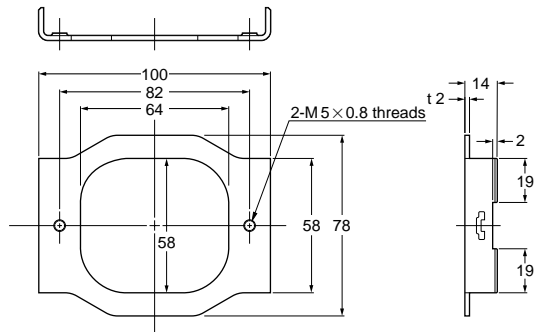

Material: Stainless steel (SUS304)
2 Nos. each of M5 (length 15mm) hexagon-socket-head bolts, spring washers and plain washers are attached.

UA-B Steel belt (Optional)

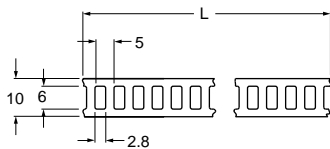

Material: Stainless steel (SUS304)

• Length

Model No.	L
UA-B10	10m
UA-B20	20m

UA-BK1 Buckle (Optional)

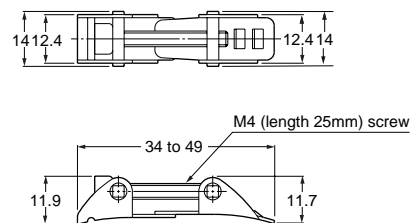

Material: Stainless steel (SUS304)